

PRO Series Specification

DF8

48V-10mm



【General description】

- Light line and dot-free with big emitting angle,
- 15m long strip driven by one end power supply.
- CRI>90,86LM/W@4000K
- suit for furniture lighting and decorative lighting application
- 7 colors optional 2700K/3000K/4000K/6500K/R/G/B

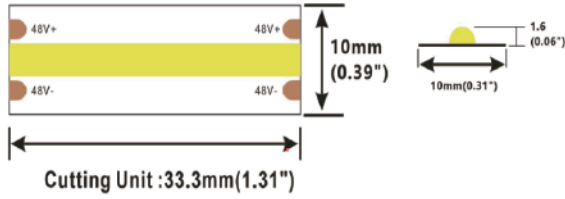

【Dimension】

- | | |
|-------------------------------------|----------------------------------|
| Input voltage: DC48V | Max.length: 15000mm(49.21') |
| CRI: 90 | Cutting unit: 33.3mm(1.31") |
| Max.power: 11.2W(1m) | LED pitch: / |
| Power range: 8.8~11.2W(1m) | Min. bend diameter: Φ60mm(2.36") |
| Rated current: 0.21A(1m) 2.63A(15m) | Mounting: 3M tape |
| Typical Power: 10W(1m) 126W(15m) | Copper foil: 3oz |
| tape IP: IP20/IP65/IP67 | |
| On-off times: 10000 (test times) | |
| Warranty: 5years | |
| (Warranty is based on indoor use) | |

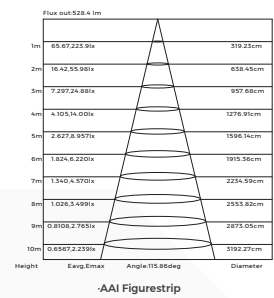
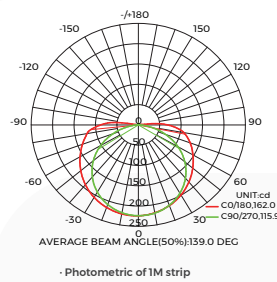

【Photo-electric Parameters】

CRI	Color	CCT	Lumen(lm/m)	Lumen(lm/ft)	lm/W	ErP 2019
Ra>90	SW	2700K	790	240	79	/
Ra>90	WW	3000K	830	253	83	/
Ra>90	NW	4000K	860	262	86	/
Ra>90	W	6500K	860	262	86	/
/	R	620-630nm	/	/	/	/
/	G	520-530nm	/	/	/	/
/	B	450-460nm	/	/	/	/



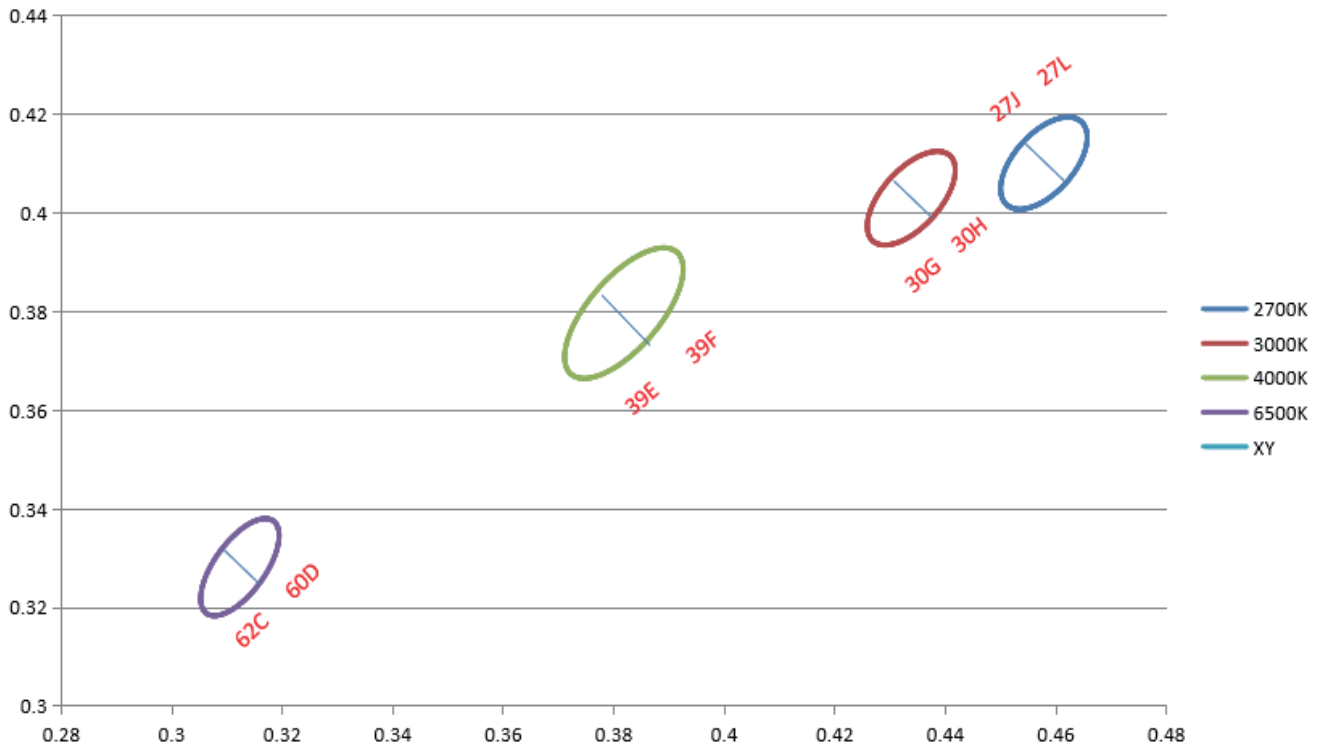

- 1.The tolerance of output data can be vary up to 15%.
- 2.the output data tested according to IES TM-30-15.
- 3.the output data is based on IP20/lmerter, data of 5m in only for reference.
- 4.IP protection process leads changes to size, CCT and luminous flux.

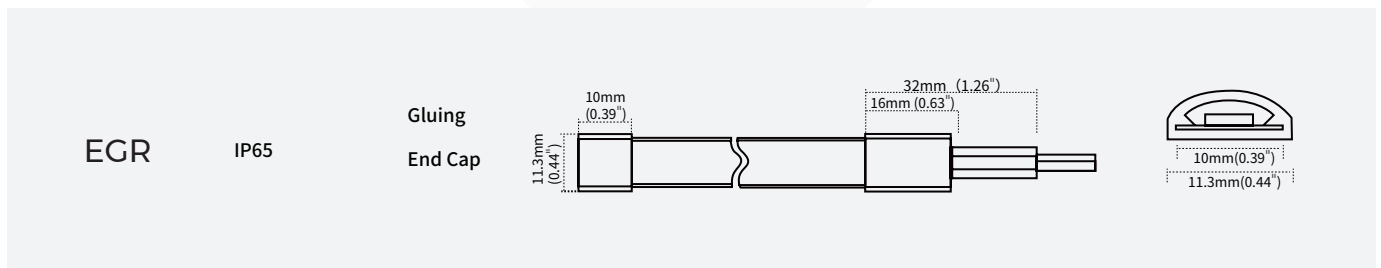
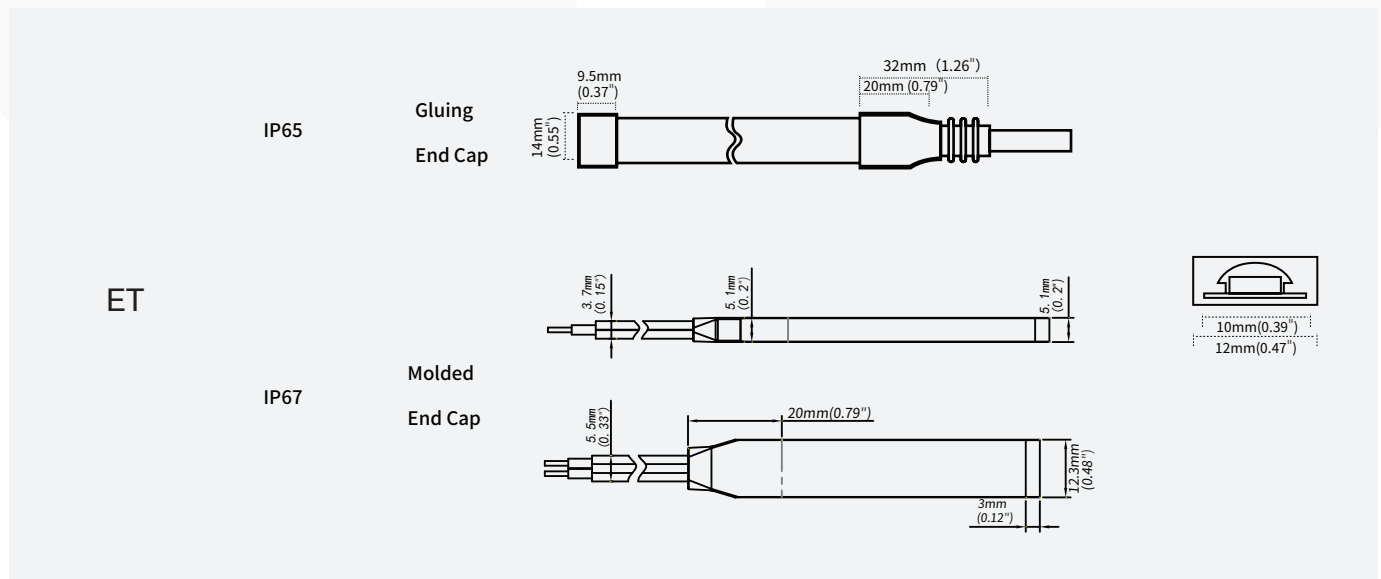













【IP process information】

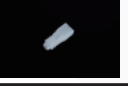

【Electronic & output data】

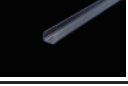
IP Process	Picture	Picture description	Size	optional CCT/color for finished product	lumen output rate
NO		No proof	10mm*1.6mm	2700K/3000K/4000K/6500KR/G/B	100%
NA		Nano-proof	10mm*1.6mm	2700K/3000K/4000K/6500KR/G/B	98%
ET		Extrusion tube	12mm*4.8mm	2700K/3000K/4000K/6500KR/G/B	88%
EGR		Milky white all-inclusive hollow arc extrusion	11.3mm*3.8mm	2700K/5000K/R/G/B	80%

【Accessories Information】

Name	Picture	Code	coding	description
Connector for FPC and FPC		81-01-000002-000038	CBB210-NOTA	10MM-2P solder-free connector (board-to board)\ suitable for bare board 10mm width strip light
Connector for wire and FPC		81-01-000002-000039	CXB210-NOTA	10MM-2P solderless connector(wire to board)\ Compatible with 20&22AWG wire\20#(6A);22#(4A)\ Applicable to bare board 10mm width lamp strip
L-connector for FPC and FPC		81-01-000002-000053	CBBL210-NOTA	10MM-2P solderless (L) connectors (board-to board)\ for bare board 10mm width light strip
Fixed Clip		94-02-00-0003	FSW10SA	Silicone clip, screw: PA 3*8mm, suitable for 10mm FPC,EF/ET strip
Gas phase rubber plug		94-02-00-0040	DT10EG-A	Translucent gas phase adhesive plug, suitable for 10mm wide silicone extrusion eg lamp with plug
Gas phase gel plugging		94-02-00-0041	DW10EG-A	Translucent gas phase adhesive plug, suitable for 10mm wide silicone extrusion eg lamp with end plug
Silicone Plug Kit		94-02-00-0046	DT10EA-A	Silicone plug kit is suitable for 10mm board width, ET/EF series silicone extrusion light strip
Silicone stopper kit		94-02-00-0047	DW10EA-A	Silicone tail plug kit is suitable for 10mm board width, ET/EF series silicone extrusion light strip
Mounting groove		94-02-00-0025	CVT10EA-14100100	Transparent PVC mounting groove,suitable for 10mm FPC,silicone extruded EF/ET strip
Stopper glue		94-16-03010001	AS-PG-0003	Silicone gel,suitable for ET/EF/EG waterproof LED strip
ET solderless plug		94-03-00-0030	PT210-ETWA	Monochromatic light strip, 10mm board width, ET protection technology
ET press-fit terminals		94-03-00-0031	CBX210-ETWA020	Monochromatic light strip, 10mm board width, ET protection technology
ET press-fit terminal kit		94-03-00-0032	STBX210-ETWA020	Monochromatic light strip, 10mm board width, ET protection technology

【Packing】

Colors brand package(NONA)

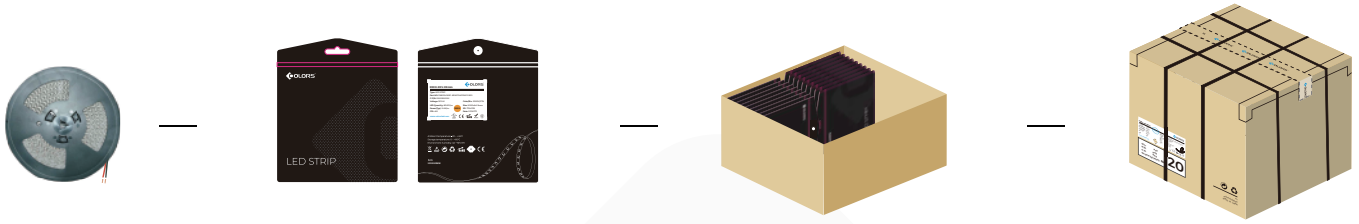

General customized package(ET)

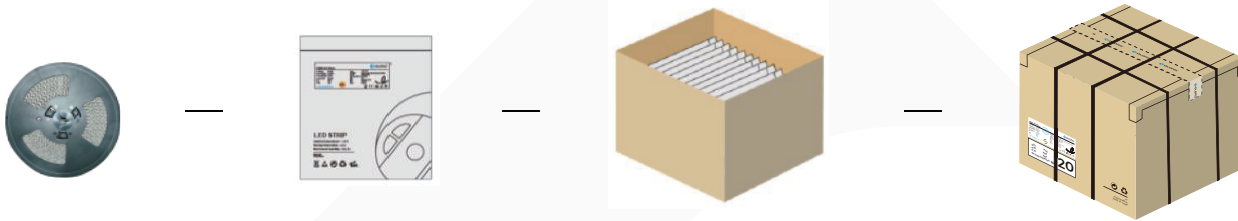

IP Process	Product size(mm)	Product quantity (m/reel)	Product quantity (m/case)	Product net weight(kg)	Net weight per box(kg)	Gross weight(kg)	Package size (cm)
NO	15000*10*1.6	15	750	0.24	12	13.80	41*41*26
NA	15000*10*1.6	15	750	0.25	12.5	14.38	41*41*26
ET	15000*12*4.8	15	150	1.4	14	16.10	41*41*26
EGR	15000*11.3*3.8	15	150	0.9825	9.825	11.30	41*41*26

Remark: data with 10% tolerance

· Engineering packaging of NO(IP20)/NA(IP65).



· Engineering packaging of ET(IP67)

(free-soldering end caps with 40 cover per box could be ordered separately if needed)



IP Process	Product size(mm)	Product quantity (m/reel)	Product quantity (m/case)	Product net weight(kg)	Net weight per box(kg)	Gross weight(kg)	Package size (cm)
NO	50000*10*1.6	50	500	1.2	12.5	14.4	41*41*26
NA	50000*10*1.6	50	500	1.3	13	14.7	41*41*26
ET	50000*10*4.8	50	100	4.8	9.6	11.04	25.5*25.5*26
EGR	50000*11.3*3.8	50	100	3.275	6.55	7.5325	25.5*25.5*26

Remark: data with 10% tolerance

【Precautions】

- Please drive the led strip with 48VDC isolated power, and the ripple of the constant voltage source should be less than 5%.
- Please do not bend the strip into an arc with a diameter less than 60mm to ensure the longevity and reliability.
- Do not fold it in case any damage of LED beads.
- Do not pull the power wire hard to ensure the longevity. Any Crash may damage the LED light is prohibited.
- Please make sure the wire is connected to the anode and cathode correctly. The power output should be consistent with the voltage of the strip to avoid damage.
- LED lights should be stored in dry, sealed environment. Please only unpack it before usage. Ambient temperature: -25℃~40℃. Storage temperature: 0℃~60℃. Please use the strips without waterproof within indoor environment with humidity less than 70%.
- Please be careful during operation. Do not touch the AC power supply in case of electric shock.
- Please leave at least 20% power for the power supply during using to ensure there is enough power supply to drive the product.
- Do not use any acid or alkaline adhesives to fix the product (e.g.: glass cement).
- Do not scratch the product when IP process of the product is NA. Ultraviolet rays will damage the nano-layers on the product and seriously affect the life of the product.